

sealskin

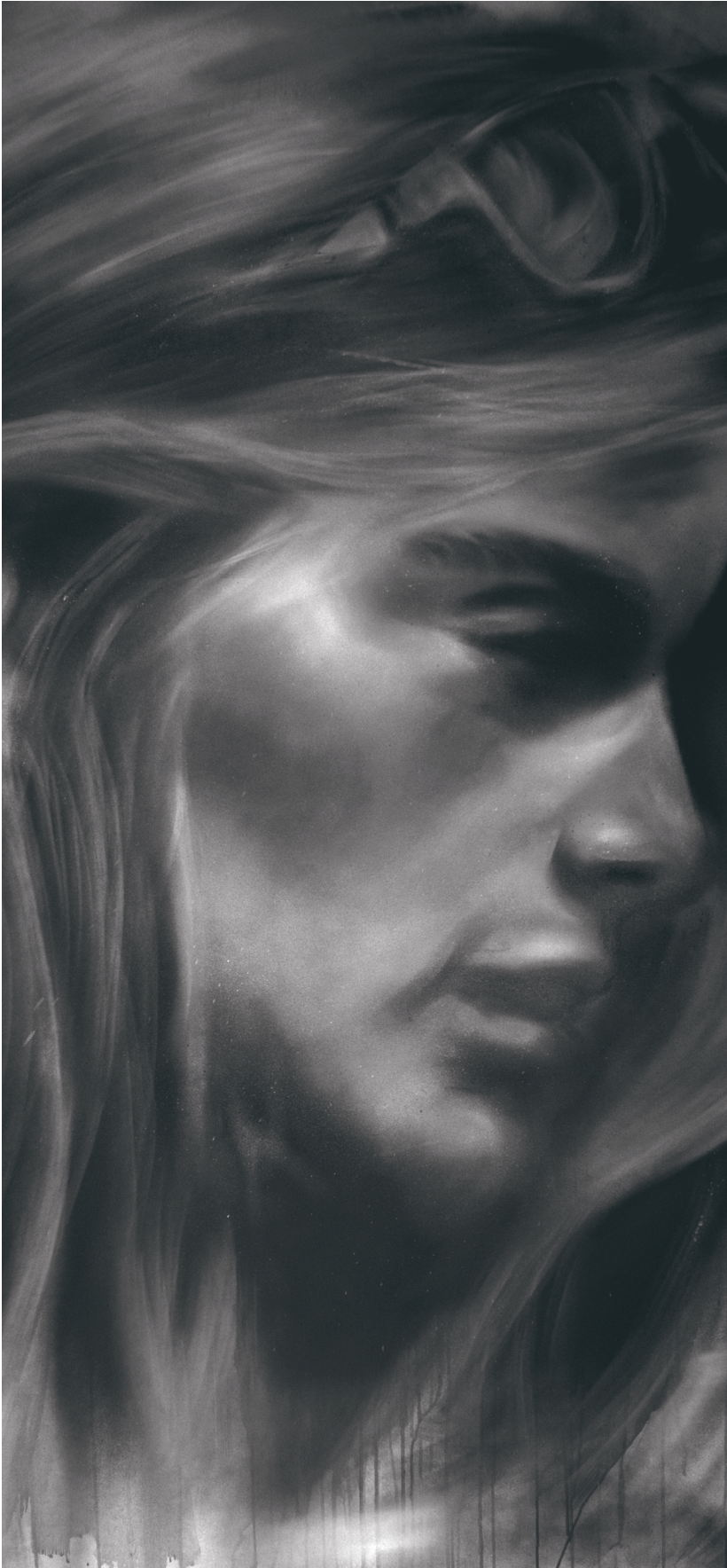

KB17
KB18
KB01

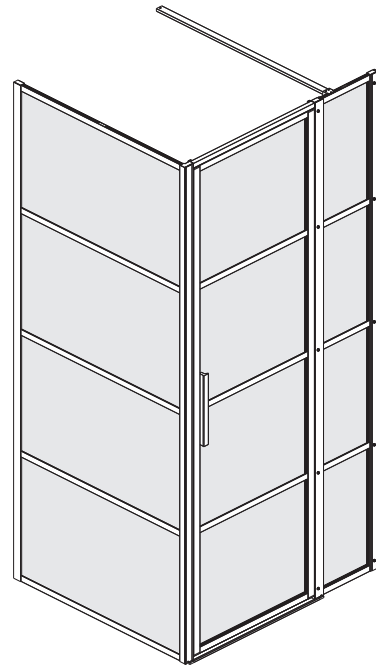
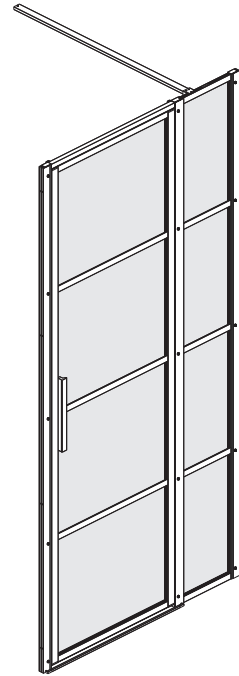

SOHO

Included

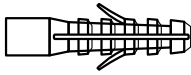

MUUR PLUG
CHEVILLE
WALL ANCHORS



SCHROEVEN
VIS
SCREWS



INBUSSLEUTEL
CLÉALLEN
ALLEN KEY

Additional tools

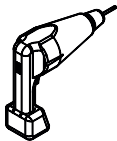

BOOR
PERCEUSE
DRILL

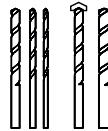

BOOR BITS: 3.0MM, 6.0MM
FORETS: 3.0MM, 6.0MM
DRILL BITS: 3.0MM, 6.0MM
DRILL BITS: 4.0MM, 6.0MM

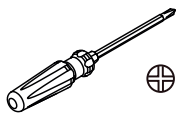

SCHROEVENDRAAIER
TOURNEVIS
SCREW DRIVER



SILICONENKIT
SILICONE
SILICONE

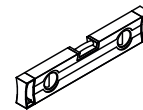

WATERPAS
NIVEAU
BUBBLE LEVEL

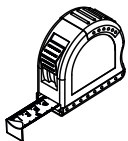

MEETLINT
RUBAN À MESURER
MEASURING TAPE



POTLOOD
CRAYON
PENCIL

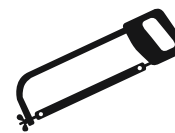

IJZER ZAAG
SCIE À FER
METAL SAW

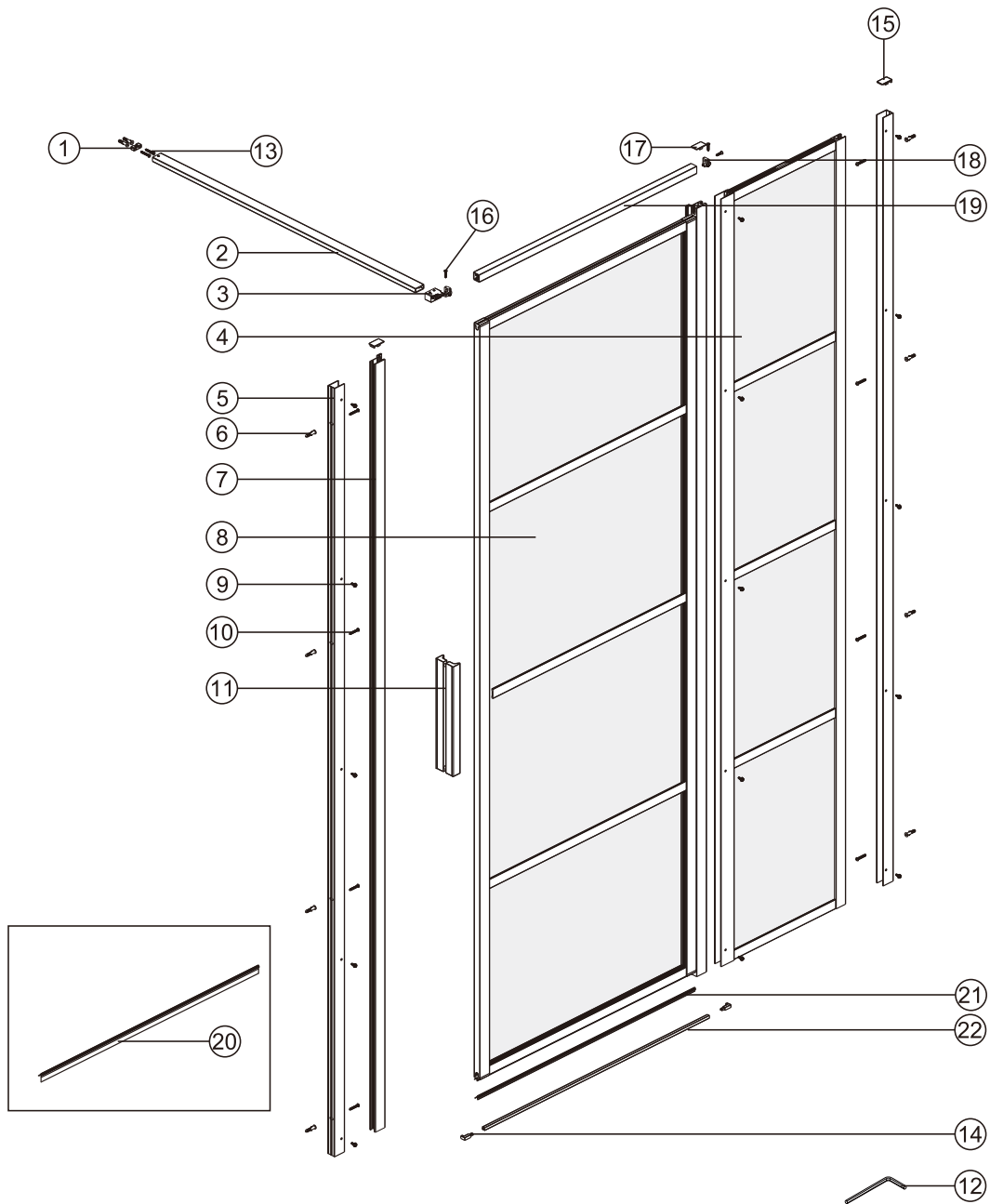

NO	Qty	Description	NO	Qty	Description
1	1	Wall bracket	12	1	Allen key
2	1	Bracing bar	13	2	Cross head countersunk screw ST4X30
3	1	Bracing bar clip	14	2	Threshold part L/R
4	1	Fixed panel	15	2	Fixed panel profile top cover
5	2	Wall profile	16	4	Cross head countersunk screw ST3.5X20
6	10	Wall anchor	17	1	Wall profile top cover
7	1	Magnet profile	18	2	Bracket for Horizontal bar
8	1	Door panel	19	1	Horizontal bar
9	15	Phillip head hexagon screw ST4.8X12	20	1	Bottom gasket B
10	8	Cross head screw ST4X30	21	1	Bottom gasket A
11	1	Handle	22	1	Back splash

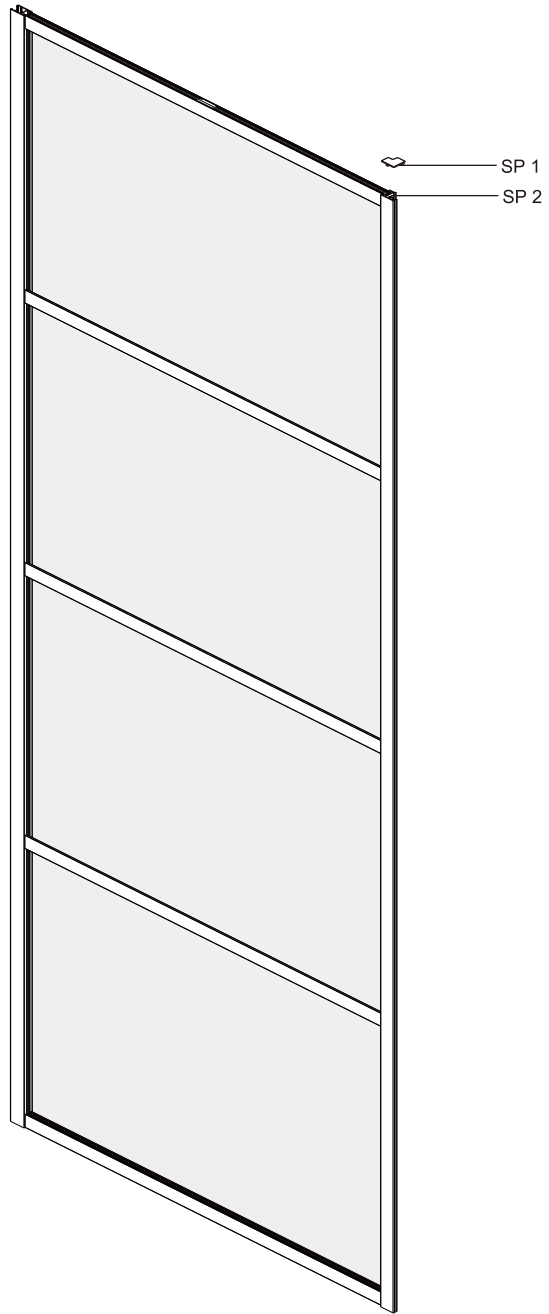

NO	Qty	Description
SP 1	1	Corner profile top cover L /R
SP 2	1	Return panel

A 01

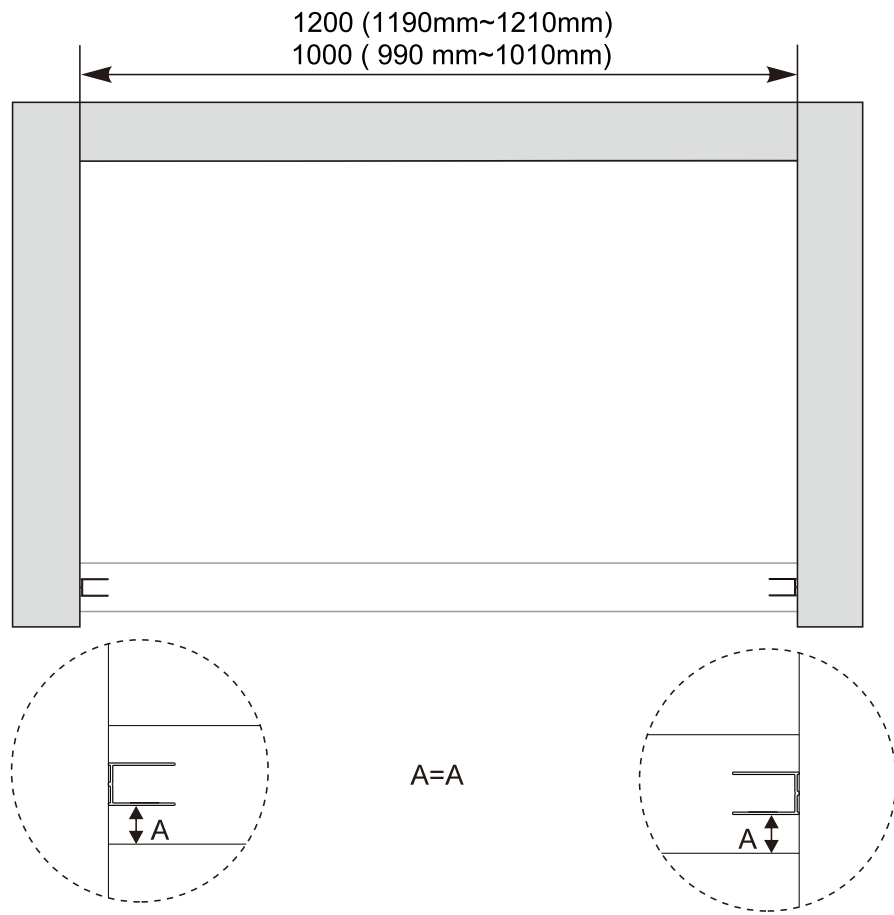

A 02

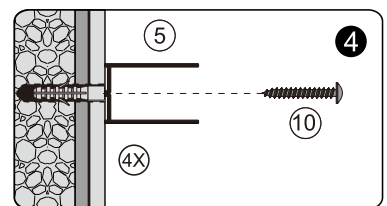
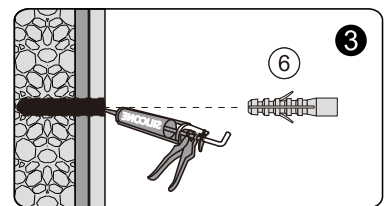
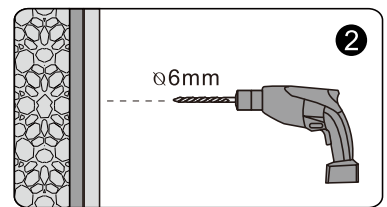
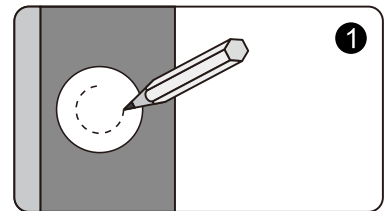
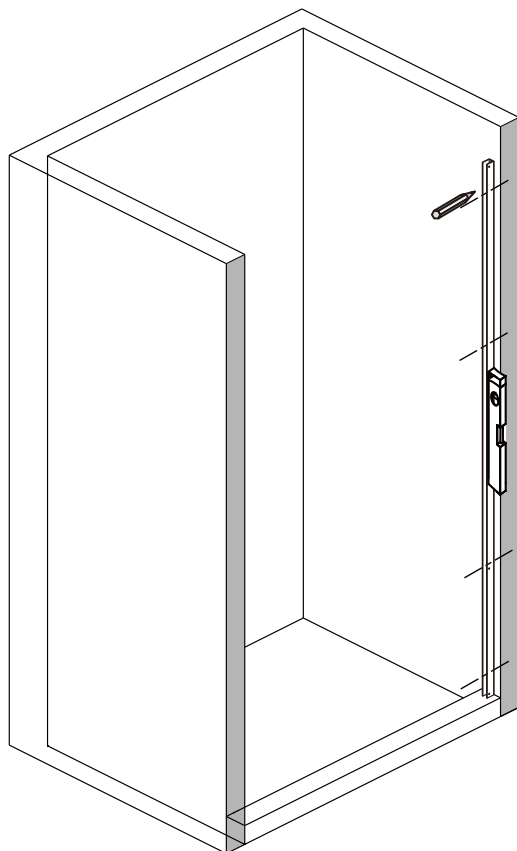

A 03

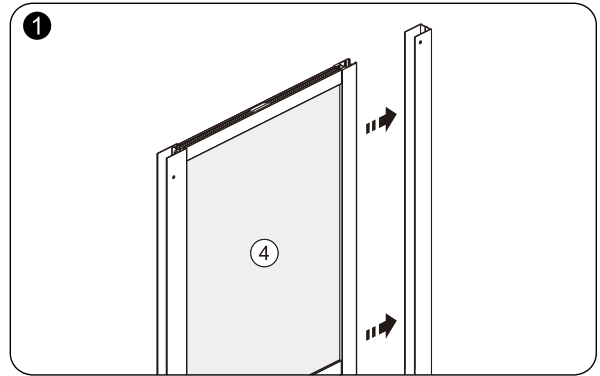
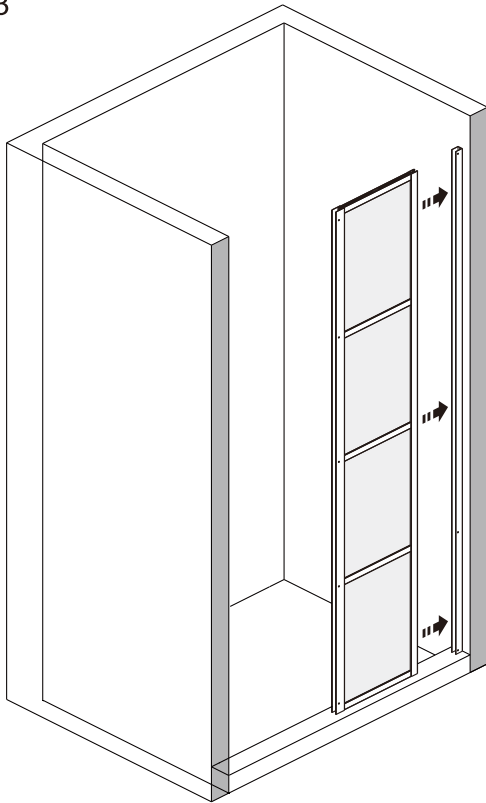

A 04

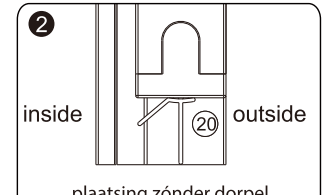
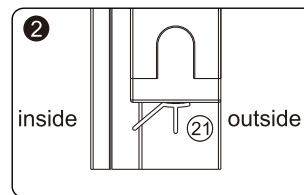
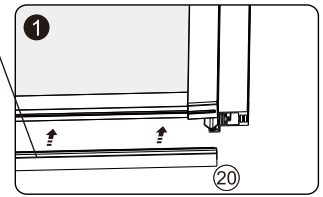
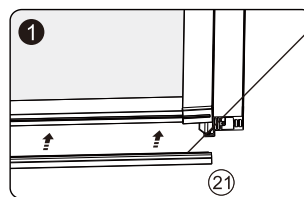
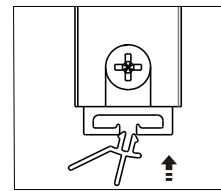
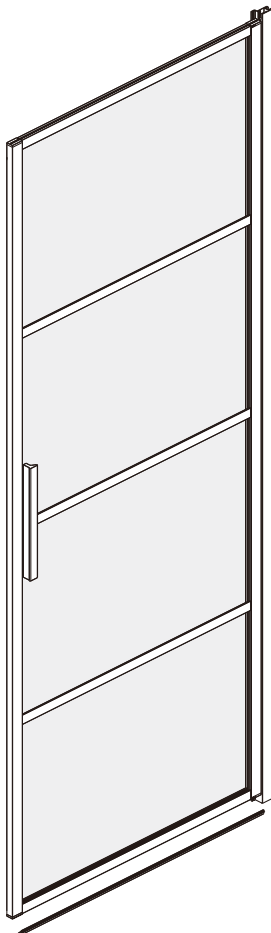

of
ou
or

plaatsing zónder dorpel
placement sans seuil
mounting without threshold

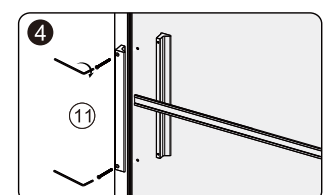
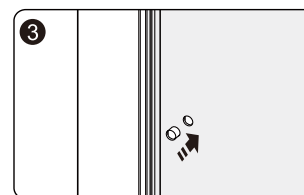

A 05

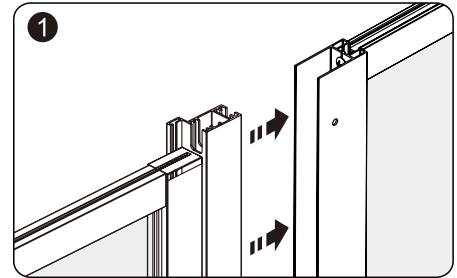
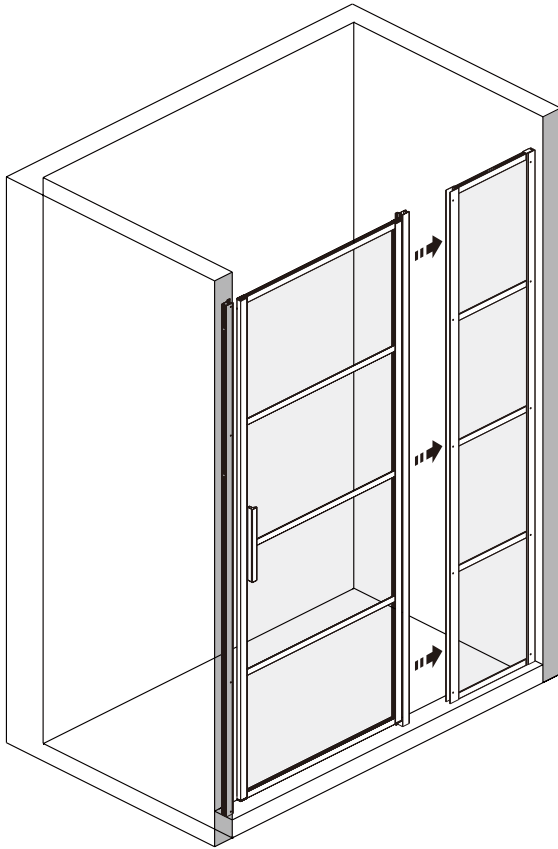

A 06

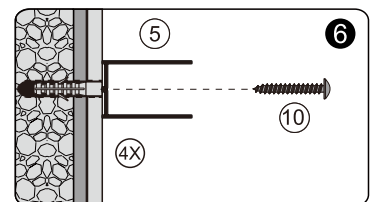
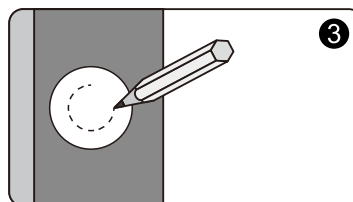
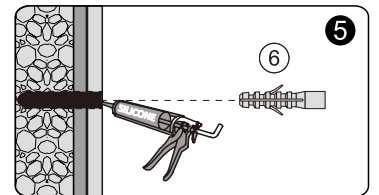
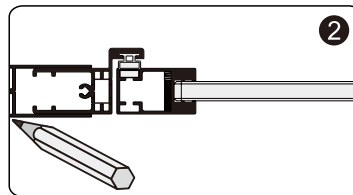
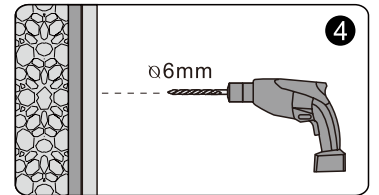
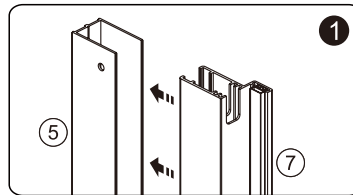
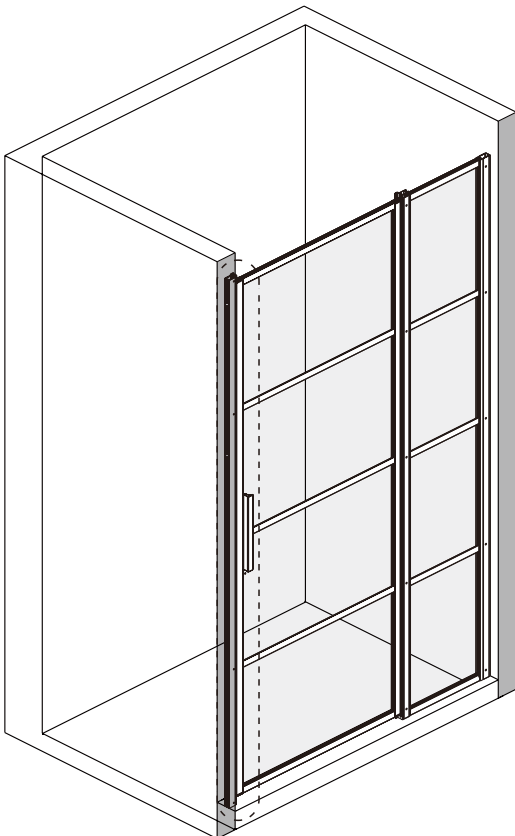

A 07

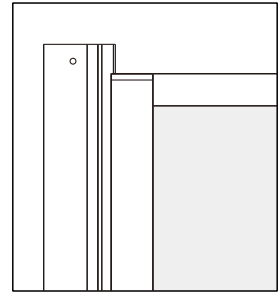
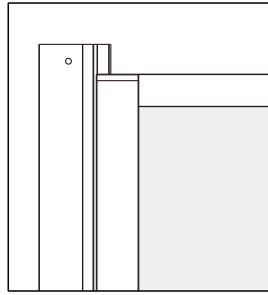
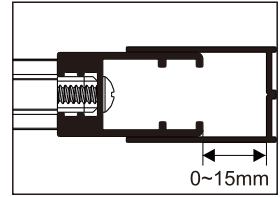
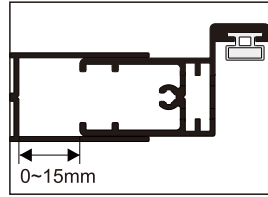
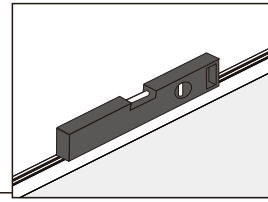
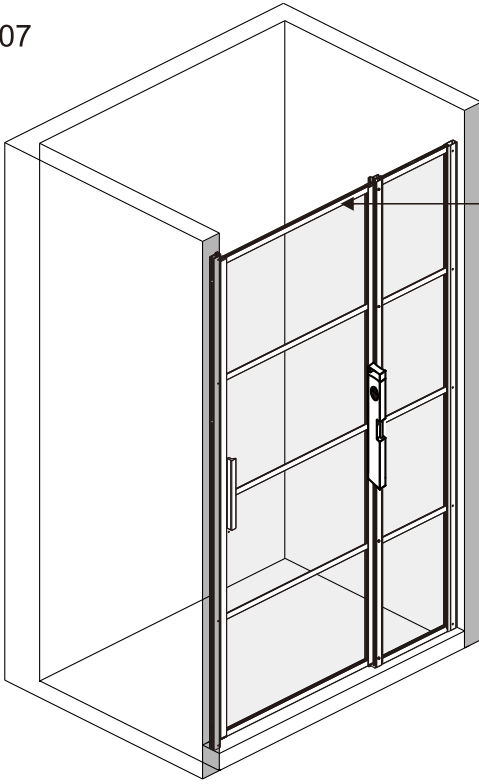

A 08

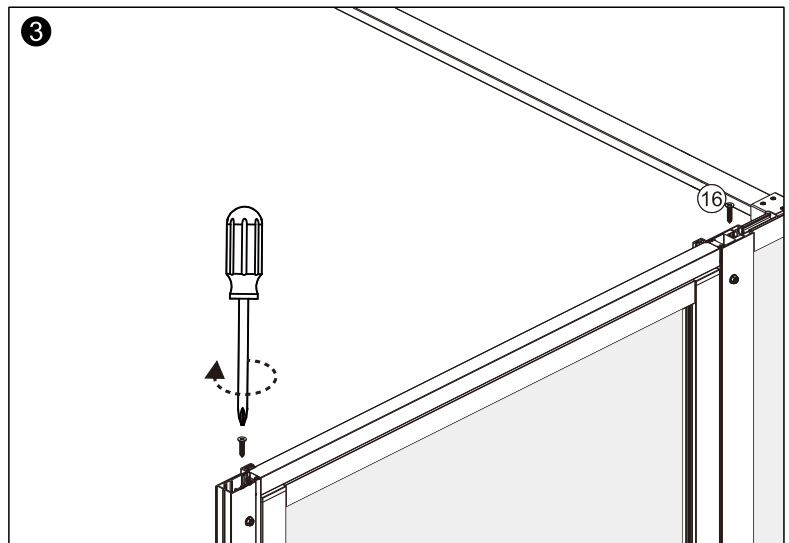
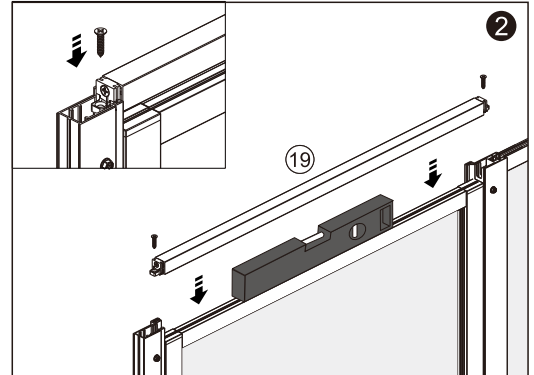
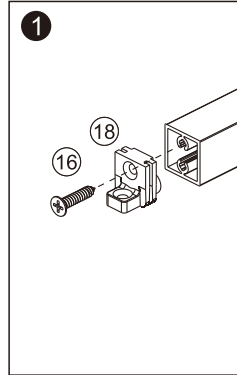
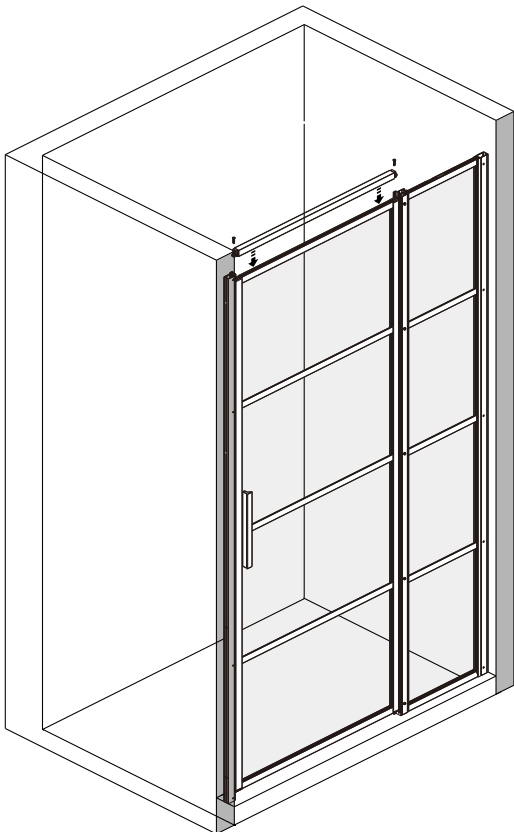

A 09

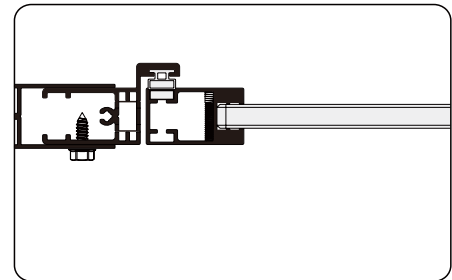
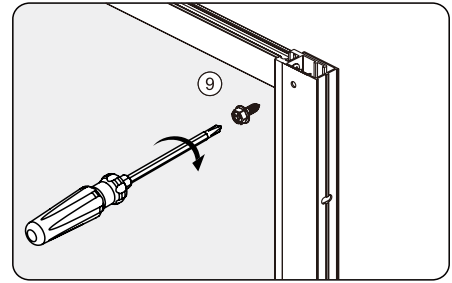
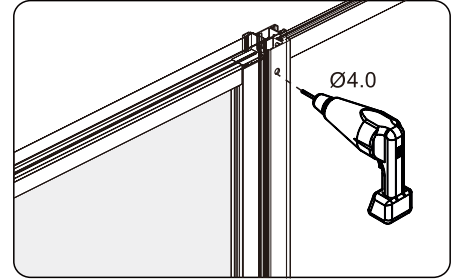
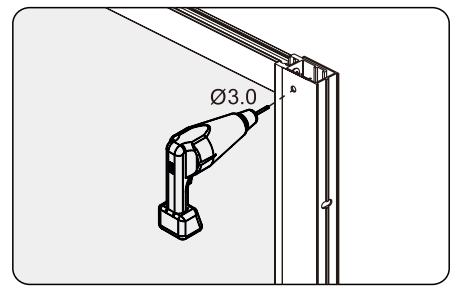
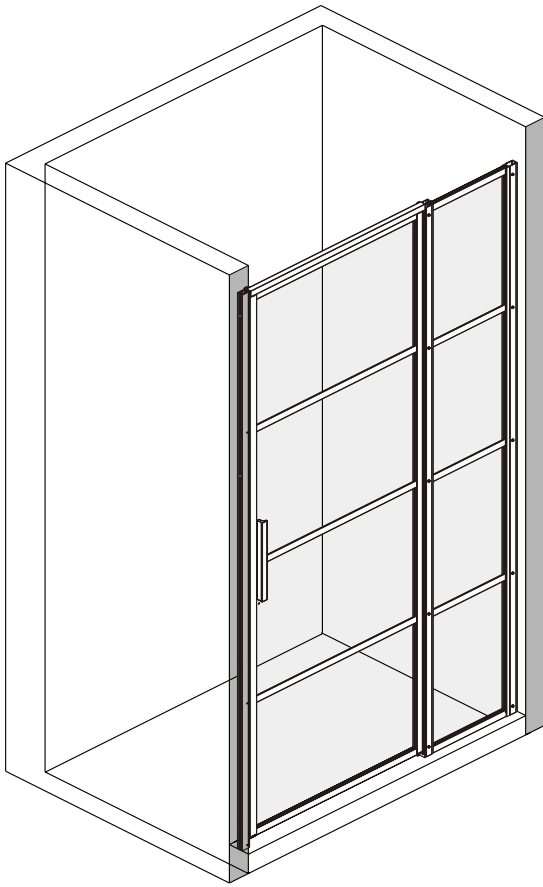

A 10

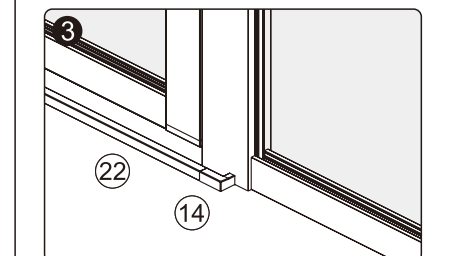
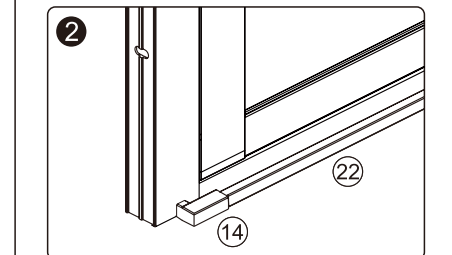
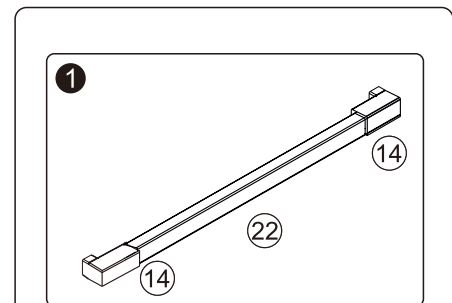
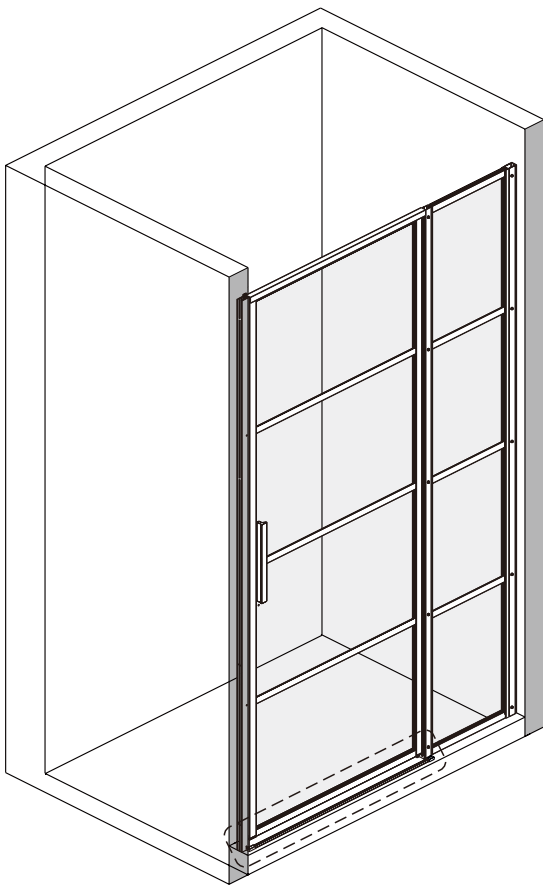

A 11

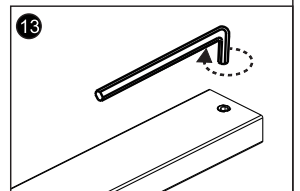
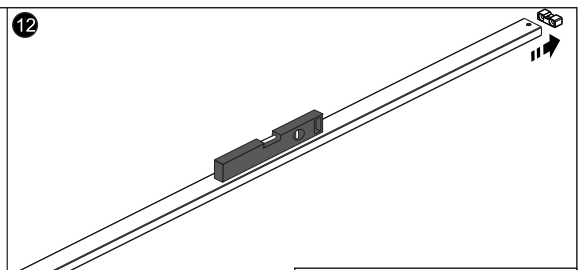
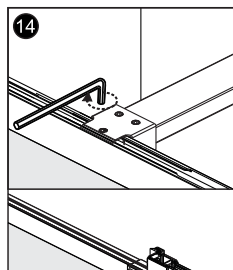
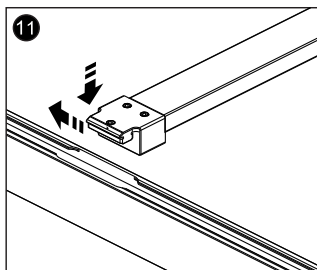
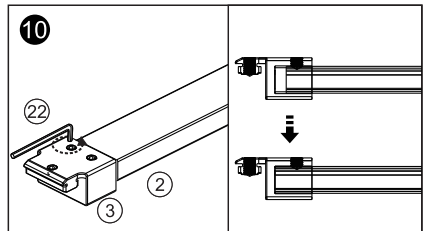
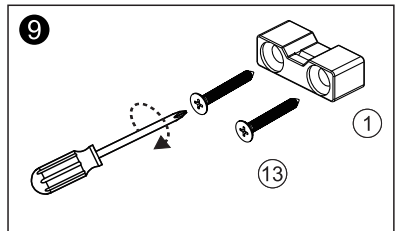
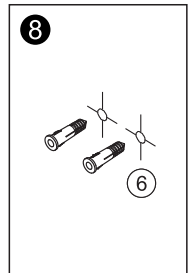
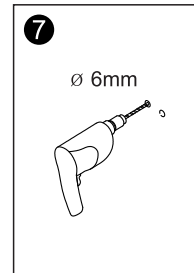
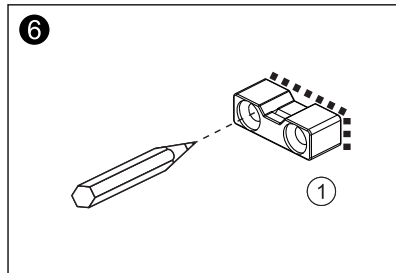
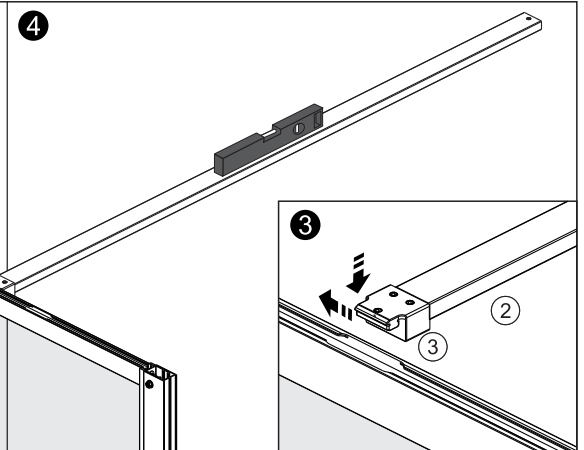
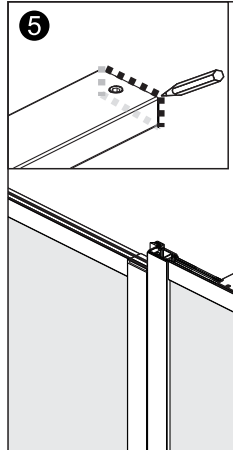
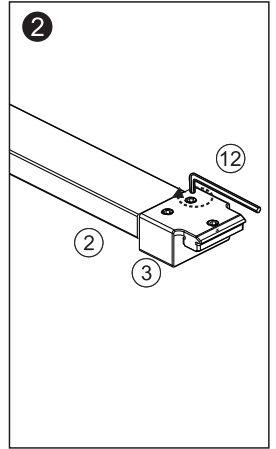
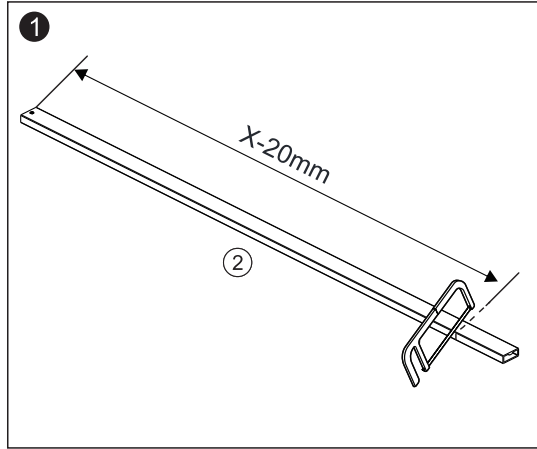
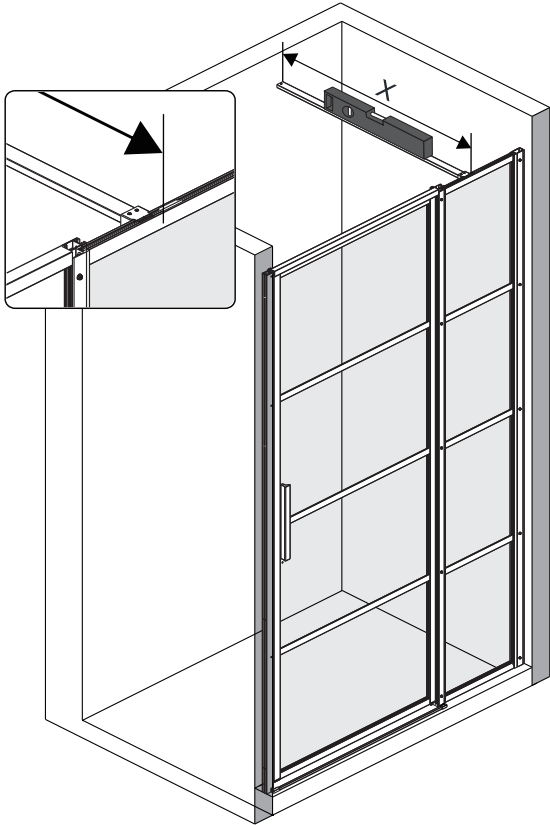

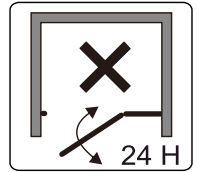
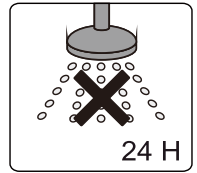
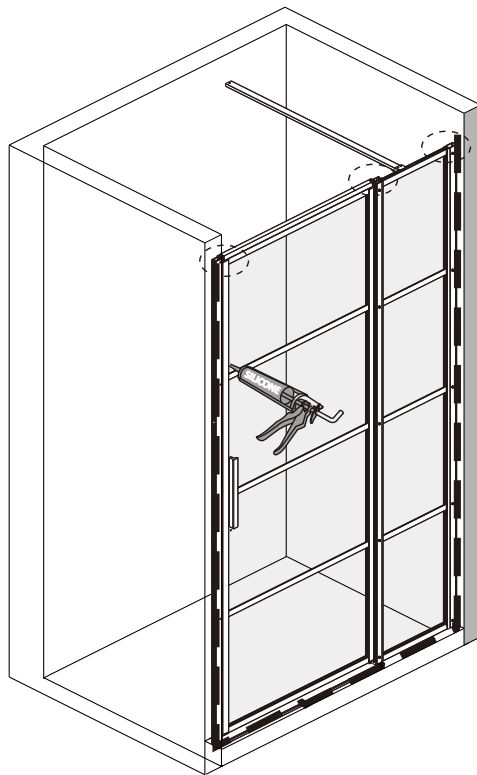
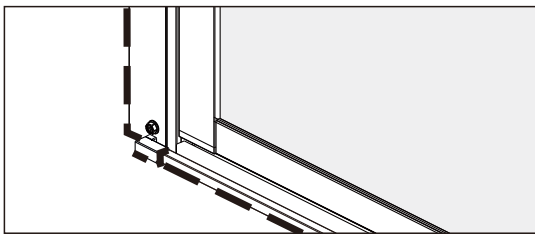
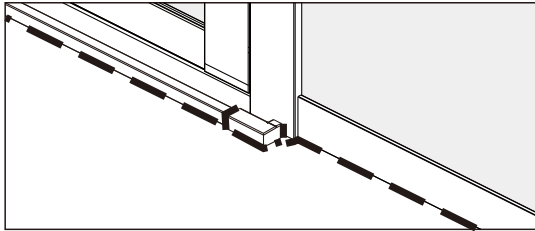
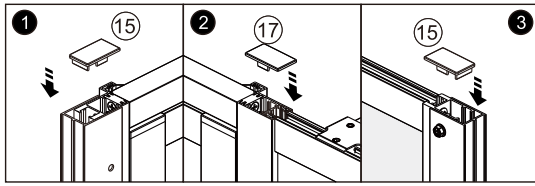

B 01

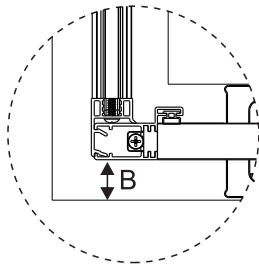
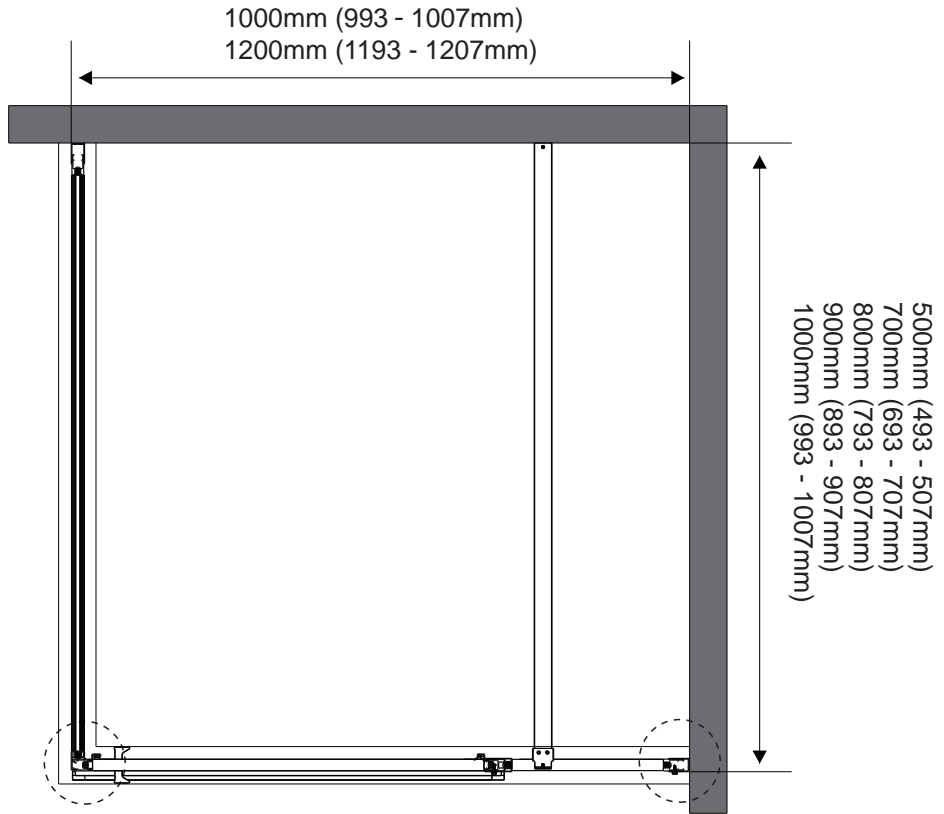

$A=B+1$

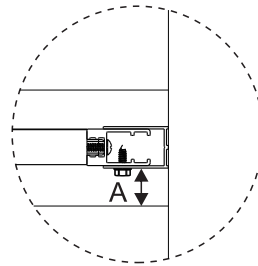

B 02

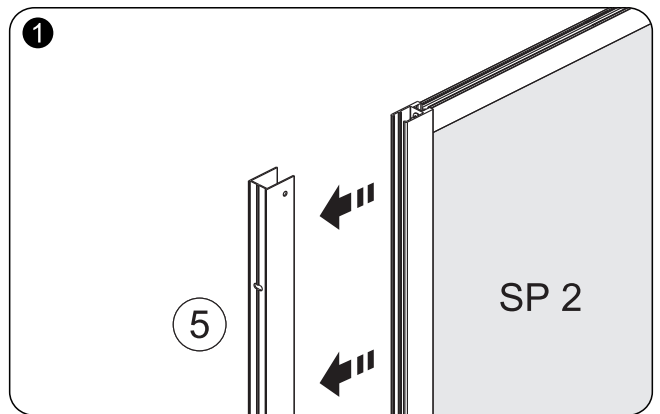
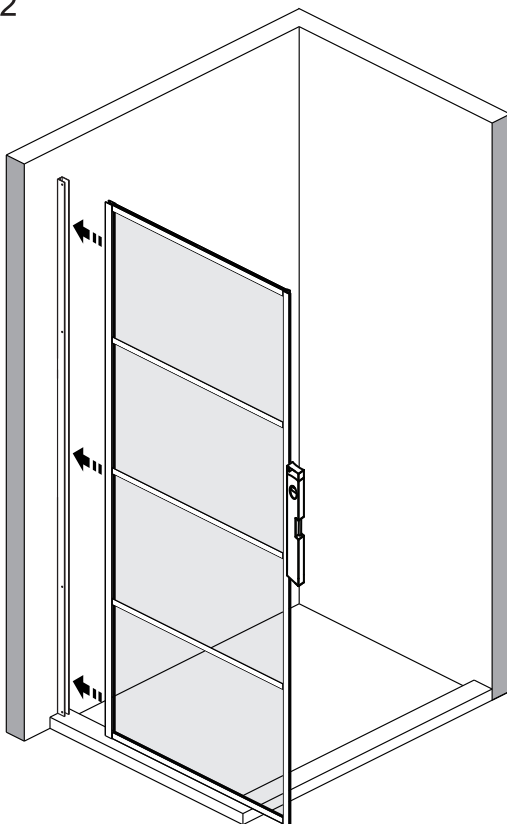

B 03

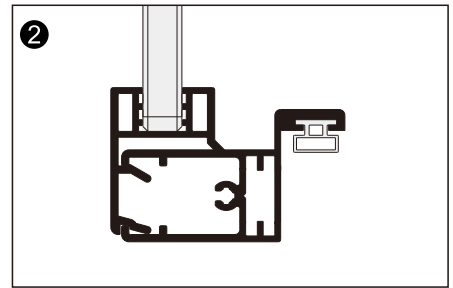
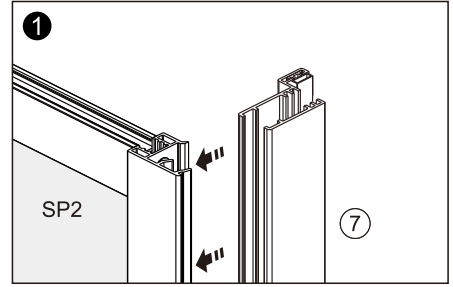
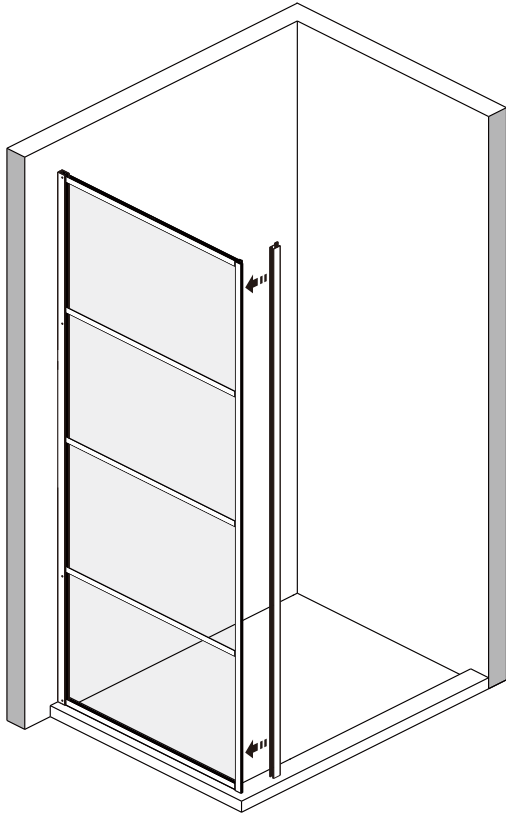

B 04

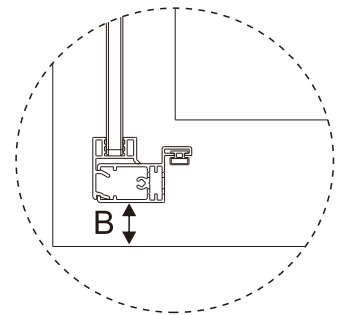
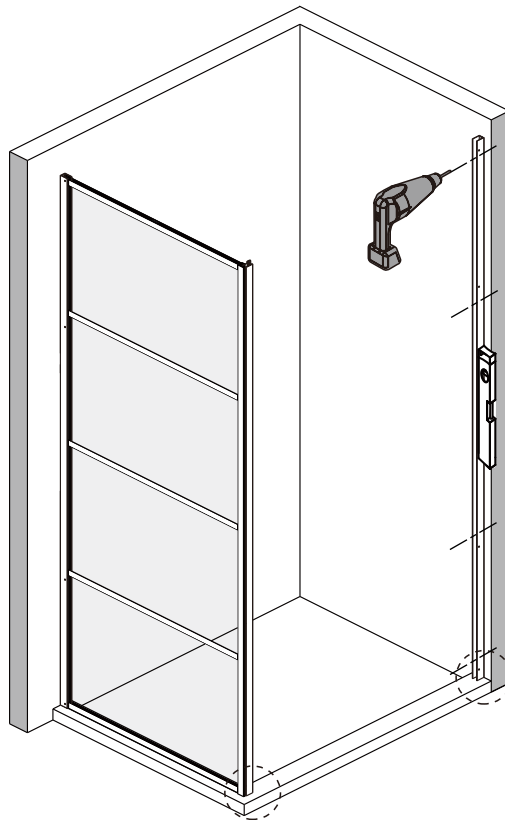
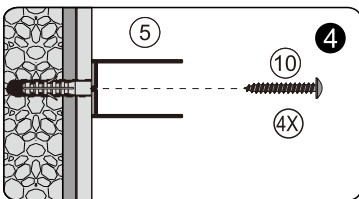
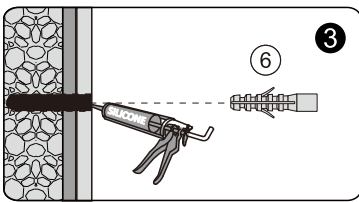
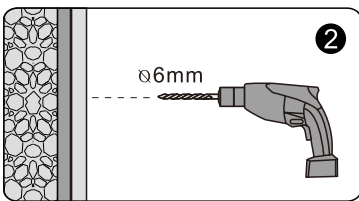
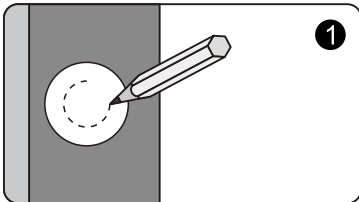

$A = B + 1$

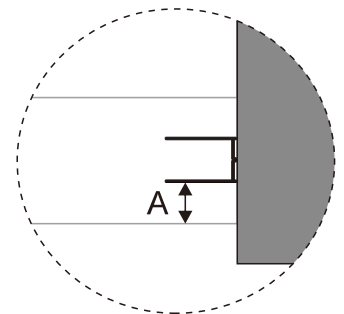

B 05

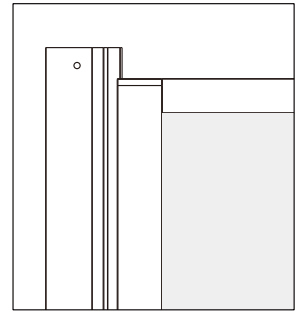
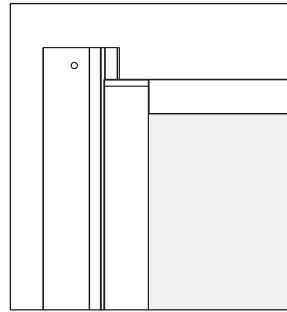
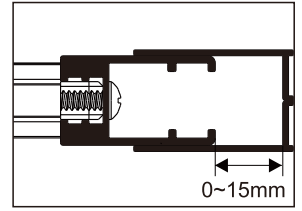
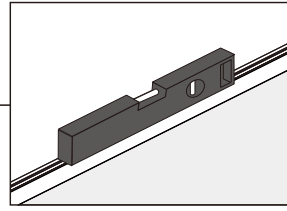
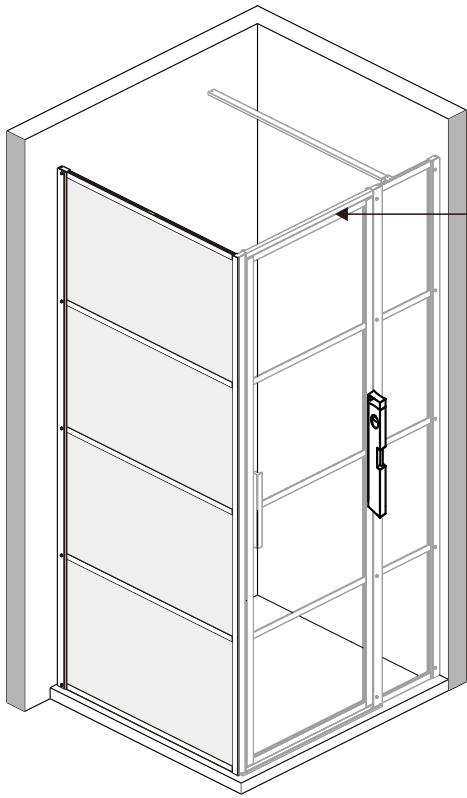

B 06

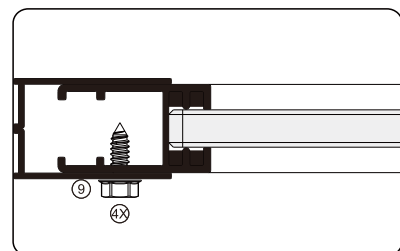
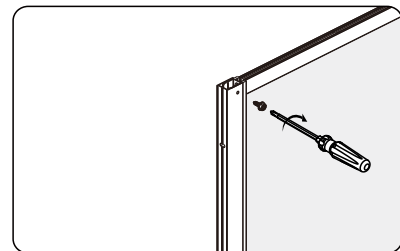
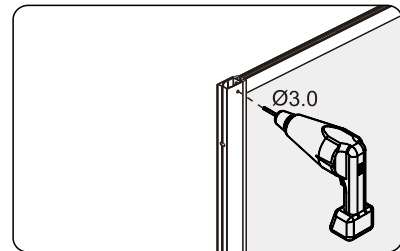
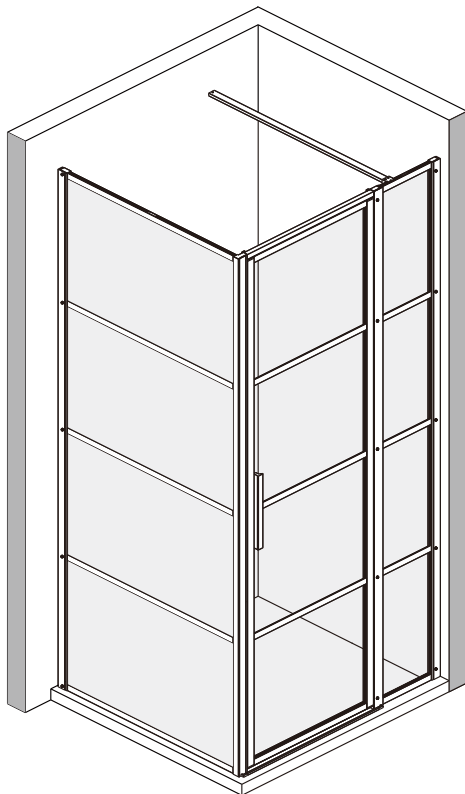

B 07

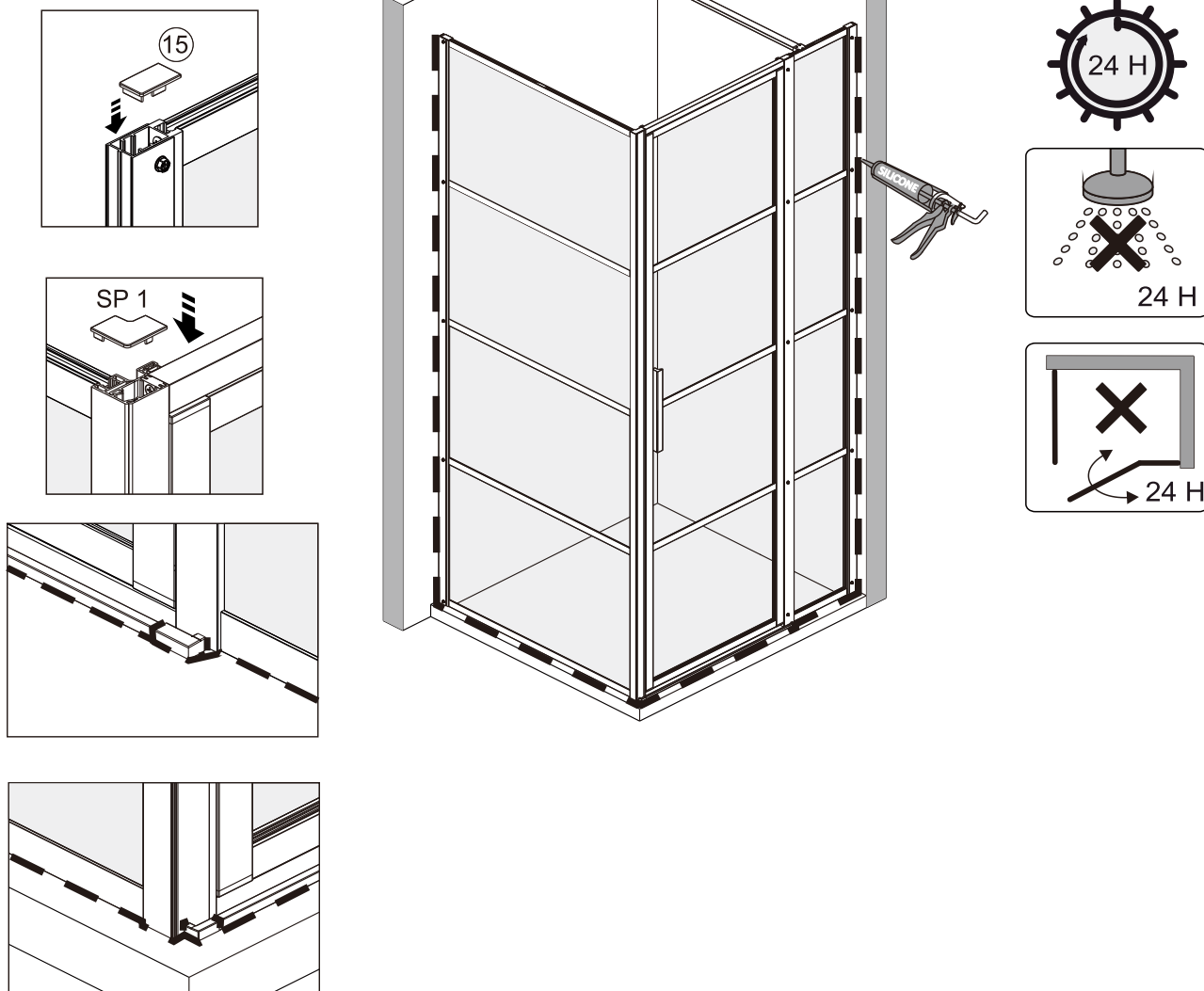

NL Voor de reiniging dient u een PH neutraal reinigingsmiddel of de aanbevolen Sealskin douchereiniger te gebruiken. Geen verdunner, alkalische, zuur, chloor of schurende middelen gebruiken.

GB For cleaning use a pH-neutral cleaning agent or the special cleaner recommended by us. Not to use are solvents, as well as alkaline, solvent -, acid- and chloric or scrubbing agents.

FR Pour nettoyer veuillez utiliser s'il vous plaît un produit de nettoyage avec PH neutre ou le produit spéciale recommandé par nous. N'utilisez pas des solvants, ainsi qu'alcalins, acides ou produits avec du clore ou agressif.

DE Zur Reinigung benutzen Sie ein PH-neutrales Reinigungsmittel oder den von uns empfohlenen Spezialreiniger. Verwenden Sie keine scheuernden, alkalischen, säure- oder chlorhaltigen Reinigungsmittel sowie Oxidations- und Lösungsmittel.

PL Do mycia i pielęgnacji proszę używać środków czyszczących o odczynie PH obojętnym lub polecany przez nas specjalny preparat. Nie należy stosować rozpuszczalników, jak również preparatów alkalicznych, kwaśnych, zawierających chlor lub posiadających w aściwości ściernie.

SOHO

KB17
KB18
KB01

Garantiebewijs
Warranty card
Garantieschein
Carte de garantie
Certificato di garanzia
Certificado de garantía

This Sealskin product has a warranty period of 5 years. Normal wear and tear on components such as gaskets are excluded from this warranty.

Wholesale dealer:

Address:

Phone:

Fax:

Installer:

Address:

Phone:

Fax:

NL De producent houdt zich het recht voor, ten alle tijde zonder tegenbericht, veranderingen door te voeren.
GB The producer reserves the right to modify the product at any time without prior notice.
DE Der Produzent behält sich jederzeit das Recht, ohne Vorbescheid Abänderungen vorzunehmen.
FR Le producteur se réserve le droit de modifier le produit sans aucun préavis.
SV Tillverkaren förbehåller sig all rätt att produktförändra
PL Producent rezerwuje sobie prawo modyfikacji produktu bez wcześniejszego powiadomienia.

sealskin 